

**A Table with Shelf**



**Features include:**

- Conductive Laminate Worktop and Shelf
- Working Height of 950mm
- Adjustable Feet

**A Bench with Drawer**



**Features Include:**

- Conductive Laminate Worktop and Shelf
- Drawer with lock
- Adjustable Feet

**A Standard Table**

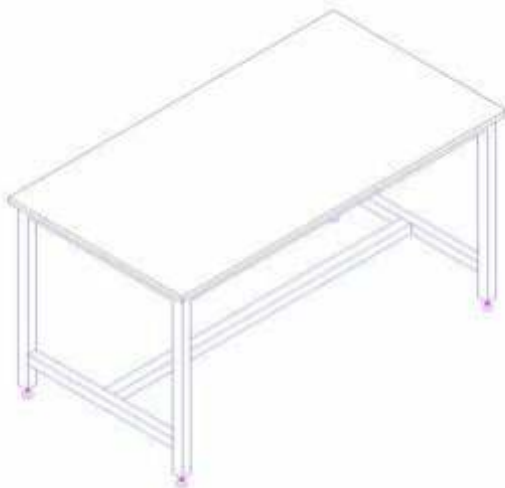

**Features Include:**

- Beige Laminated Worktop
- Working Height of 800mm
- Adjustable Feet

**A Table with Bin Holder**



**Features Include:**

- Laminated worktop with an access hole
- Frame to hold bin under access hole
- 50mm Aluminium Upstand

### A Bench with Shelving



#### Features Include:

- Conductive Worktop
- 4 Storage Units
- Sheet Metal Back & Sides

### A Bench with Shelving



#### Features Include:

- Conductive Worktop
- 9 Storage Units
- Bin inset in worktop

### A Special Purpose Pigeon Hole Table

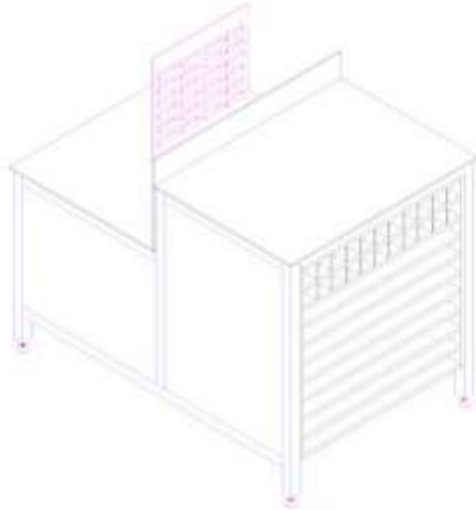

#### Features Include:

- Steel Plate Worktop
- Louvred Panel
- Medite Pigeon Holes and Shelves

### A Touch Up Workstation

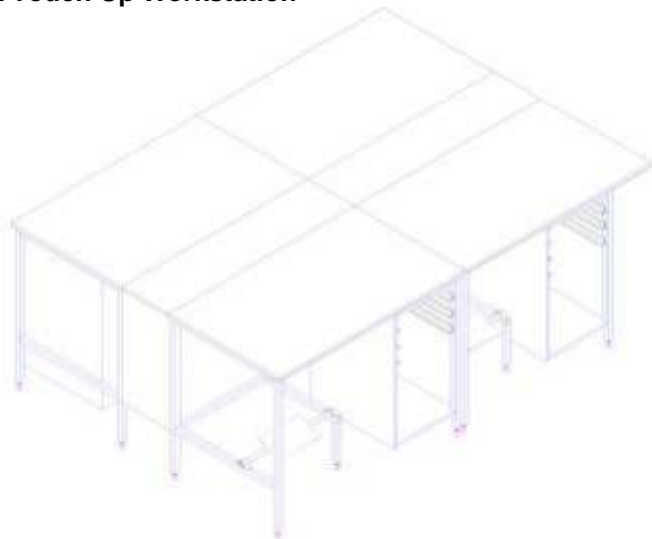

#### Features Include:

- Modular Footrest
- Service Ducting
- Tote Holders

### A Pre-Assembly Work Bench



#### Features Include:

- Left or Right Hand Orientation
- Adjustable Shelf above Worktop
- Special Trolley and Footrest

### A Conveyor Shelf



#### Features Include:

- Shelf at 1,500x300mm
- Working Height of 1425mm
- Adjustable Feet

### A Packer Bench



#### Features Include:

- Conductive Worksurface
- Removable Louvre Panel
- Adjustable Feet

### A D-E-K Stencils

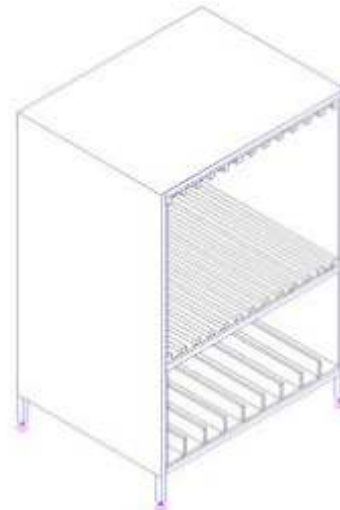

#### Features Include:

- Medite Spacers
- Sheet Metal Back & Sides
- Adjustable Feet

### A Start of Line Bench



#### Features Include:

- Conductive Worktop
- Storage Units
- Adjustable Feet

### A Bench with Shelving

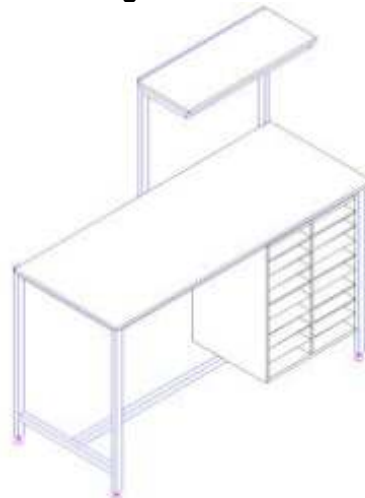

#### Features Include:

- Conductive Worktop
- Half Shelf & Storage Units
- Adjustable Feet

### A Bench with Socket Strip and Louvre Panel A Bench with Lighting and Louvre Panel

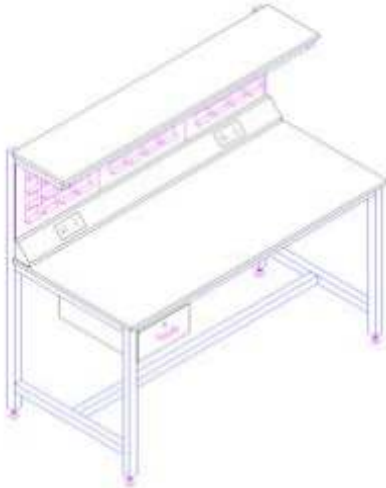

#### Features Include:

- Conductive Worktop and Overhead Shelf
- 1,500mm socket strip with 2 twin sockets
- 3 Louvre Panels

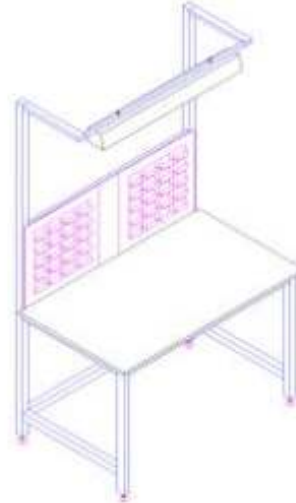

#### Features Include:

- Conductive Worktop
- Single Fluorescent Light
- Adjustable Feet

### A Workbench with Louvre Panel



#### Features Include:

- Medite Worktop
- Shelving
- 5 Louvred Panels

### A Workbench with Shelf



#### Features Include:

- Conductive Worktop
- Overhead Shelf
- Option to install drawers at a later date

### A Workstation with Tool Rail

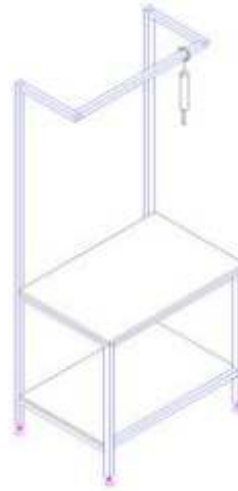

#### Features Include:

- Conductive Worktop
- Shelf at 900 x 570mm
- Foot Rest

### A Workbench with Tote-Rail and Drawer



#### Features Include:

- Conductive Worktop
- Working Height of 750mm
- Paper Work Drawers and Tote-Rails

WB Industrial Furniture Ltd, Rootiagh, Patrickwell, Co. Limerick, Ireland

T: 00 353 61 304 711

[sales@wbindfurn.com](mailto:sales@wbindfurn.com)

### A Workbench with Back Panel and Shelf



#### Features Include:

- Conductive Worktop
- Inset conductive back panel
- Medite shelving inset in steel frame

### A Workbench with Pigeon Hole Storage

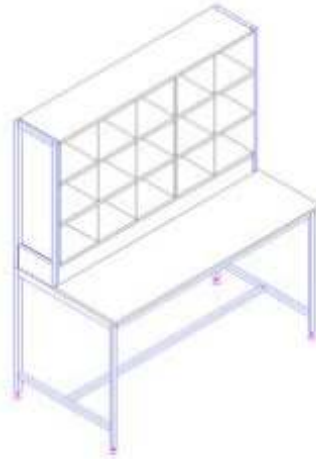

#### Features Include:

- Conductive Worktop
- 15 Pigeon hole units
- Adjustable Feet

This document is owned by WB Industrial Furniture Ltd. Although every effort has been made to ensure the accuracy of the material contained in this website, complete accuracy cannot be guaranteed. Please note that WB Industrial Furniture Ltd reserves the right to alter the data and or images in this document at any time.

Copyright of all images in this document are retained by WB Industrial Furniture Ltd and may not be downloaded and used elsewhere without the prior consent of WB Industrial Furniture Ltd.

WB Industrial Furniture Ltd, Rootiagh, Patrickwell, Co. Limerick, Ireland  
T: 00 353 61 304 711  
[sales@wbindfurn.com](mailto:sales@wbindfurn.com)